





Social 30 March 2023 Lucy Clark

MISS WELSH'S REEL			8x32 J
$\overbrace{12}$ S X_R S X_R	12 RA LA		

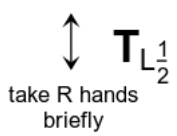
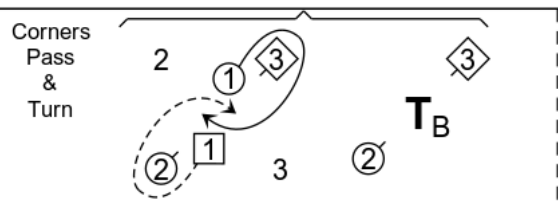
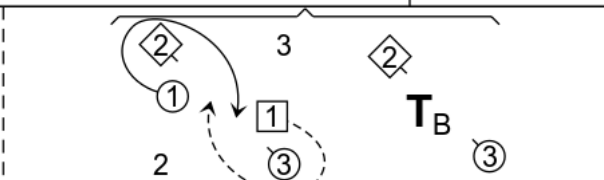

RSCDS Graded Book 1.13

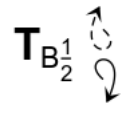
3C/4C longwise set.

TRIPLE HAPPINESS			3x32 S
	12 KNOT	Corners Pass & Turn 	
		$2\ 1\ 3$ 	$3x\ 1x\ 2x$ 

Yoshiki Oyama, 2016, RSCDS Book 52.10

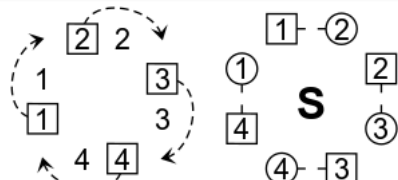
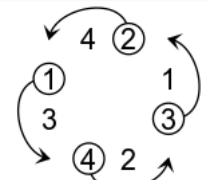

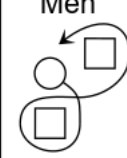
3C/3C longwise set.

THE SUMMER ASSEMBLY						88 R			
ALL T_R				R	ALL T_L			S	R
$3\ 1$ RA	$2\ 4$ R	Women 	Men 	$1\ 3$ S	$1\ 3$ S	$2\ 4$ R	8		

Roy Goldring, 1985, RSCDS Book 35.8

4C/4C square set.

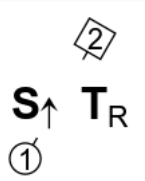
9pm to 10 pm

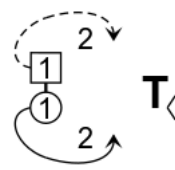
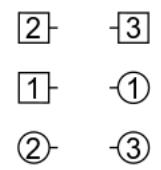
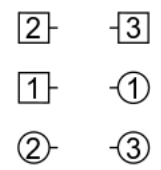
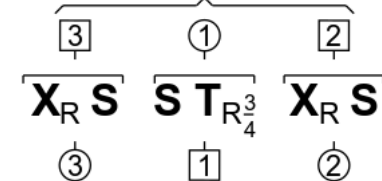
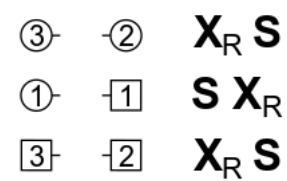
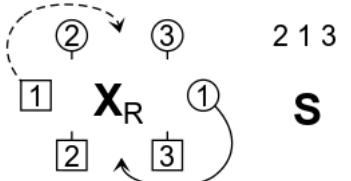
J. B. MILNE				8x32 R
				
			X_R S S T_R^{3/4} X_R S	
				
X_R S S T_R^{3/4} X_R S		X_R S S X_R X_R S		S

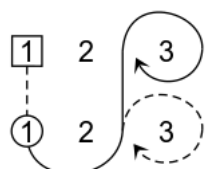
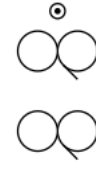
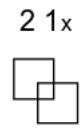
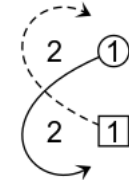

Hugh Foss, 1954, Angus Fitchet S D Album, RSCDS Thirty Popular Dances Vol 2

3C/4C longwise set.

ANDREW'S DANCE				8x32 R
				T_R

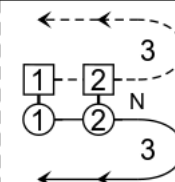

Andrew Mills, Harbour City (NZ)

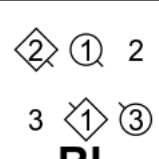
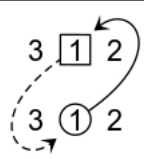
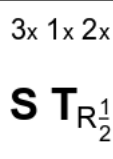
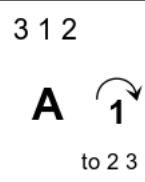
3C/4C longwise set.

BRUCE'S MEN		Caerlaverock Castle			3x32 S	
						
		RL	RL		S T_R^{1/2}	A 1 to 2 3 1

Roy Goldring, Scotia Suite

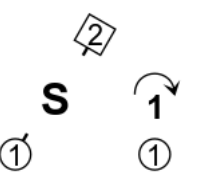
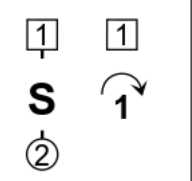
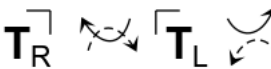
3C/3C longwise set.

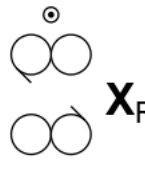
GENERAL STUART'S REEL			The New Way of Gildon		8x32 R
					
		T_R T_L		S S S S X_R	

Castle Menzies, 1749, RSCDS Book 10.3

3C/4C longwise set.